

For standby power supplies  
 Expected trickle life: 6 years at 25°C  
 10 years at 20°C

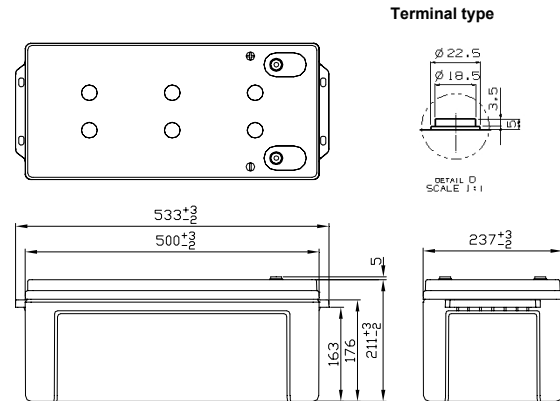

※Contents indicated (including the recycle marking, etc) are subject to change without notice.

### ■Dimensions(mm)



Battery case resin: Flame-retardant (UL94V-0)

### ■Specification

Nominal Voltage		12V
Rated Capacity(20HR)		200Ah
Dimensions	Length	533 mm
	Width	237 mm
	Height	211 mm
	Total height	216 mm
Approx. Mass		57.0 kg
Terminal		M8 threaded post

### ■Characteristics

Capacity (25 °C)	20 hour rate	200Ah
	10 hour rate	185Ah
	3 hour rate	169Ah
	1 hour rate	118Ah
Internal Resistance (25 °C)	Fully charged battery	3 mΩ
Temperature Dependency of Capacity (20 hour rate)	40 °C	102%
	25 °C	100%
	0 °C	85%
	-15 °C	65%
Self Discharge (25 °C)	After 3 months	91%
	After 6 months	82%
	After 12 months	64%

### ■Duration of discharge vs. discharge current

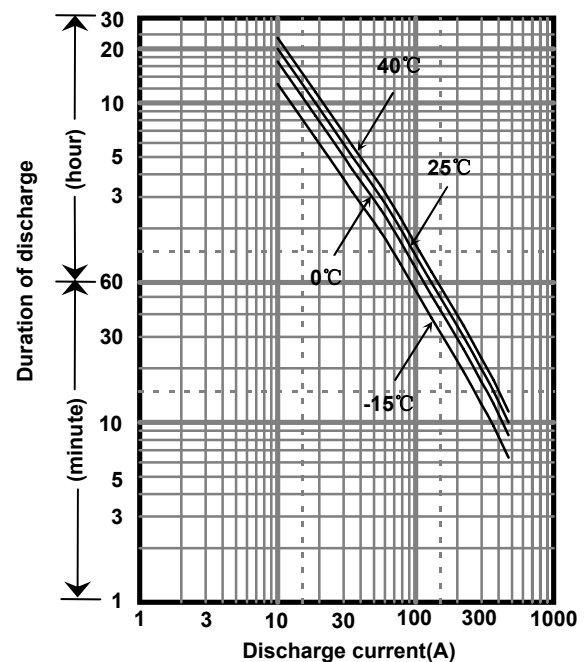

### ■Watt Table(25°C)

Cut-off V	5min	10min	15min	20min	30min	45min	1h	1.5h	2h	3h	4h	5h	6h	10h	20h
9.6V	6552	5160	4200	3356	2496	1772	1432	1053	867	643	504	420	345	225	123
9.9V	6403	5036	4092	3277	2430	1725	1386	1015	853	630	495	410	340	224	123
10.2V	5643	4649	3966	3175	2352	1674	1336	965	837	618	483	401	333	222	122
10.5V	5092	4390	3851	3085	2308	1634	1296	925	821	608	475	396	331	221	122
10.8V	4462	3876	3725	3017	2253	1573	1246	877	800	592	464	388	325	220	121

### ■Ampere Table(25°C)

Cut-off V	5min	10min	15min	20min	30min	45min	1h	1.5h	2h	3h	4h	5h	6h	10h	20h
9.6V	655	471	366	297	222	163	130	95.7	86.0	59.6	45.6	37.0	30.2	19.0	10.1
9.9V	640	460	357	290	217	159	126	92.3	84.6	58.5	44.8	36.1	29.8	18.9	10.1
10.2V	564	425	346	281	210	154	121	87.7	83.0	57.3	43.7	35.3	29.2	18.8	10.0
10.5V	509	401	336	273	206	150	118	84.1	81.5	56.4	43.0	34.9	29.0	18.7	10.0
10.8V	446	354	325	267	201	145	113	79.7	79.4	54.9	42.0	34.1	28.4	18.5	9.99

**Charging Method (25°C)**

Trickle use	Control voltage:13.6-13.8V Initial current:30.0A or smaller
-------------	--

**Cut off voltage**

Discharge current	10.0A-40.0A	40.0A-100A	100A-200A	200A-400A	400A-600A
Cut off voltage(V)	10.5	10.2	9.9	9.3	8.7

**Influence of Temperature on Trickle life**

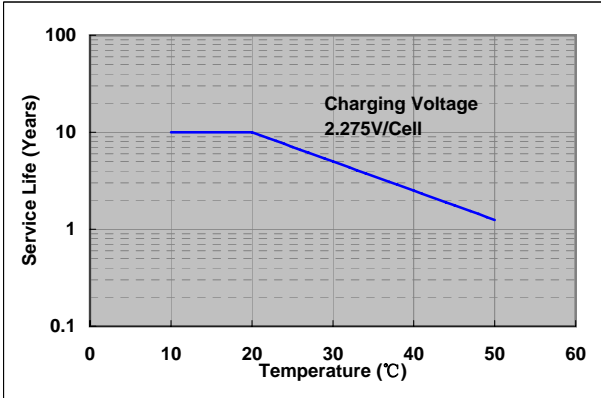

**Residual capacity test result**

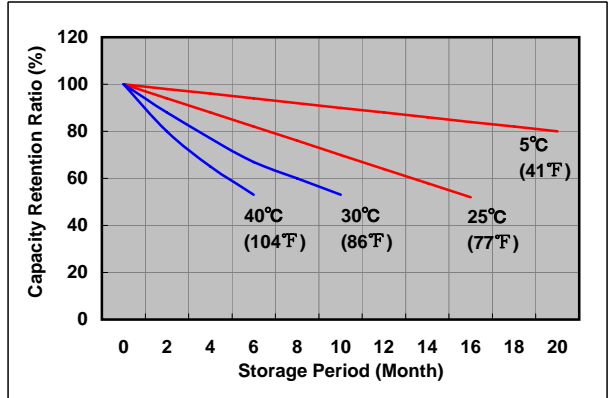

**Constant-voltage constant-current charge characteristics for Trickle use**

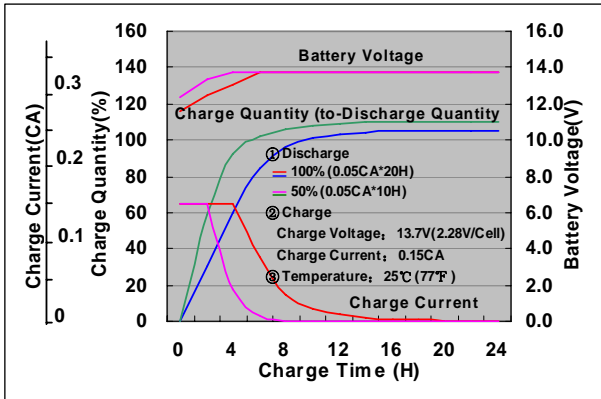

**Discharge capacity by temperature and by discharge current**

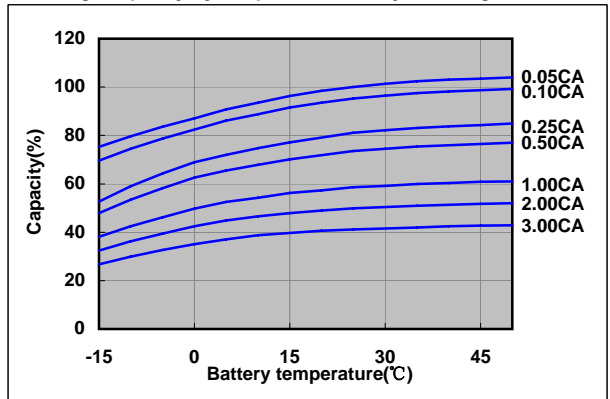

**Discharge characteristics(25°C)**

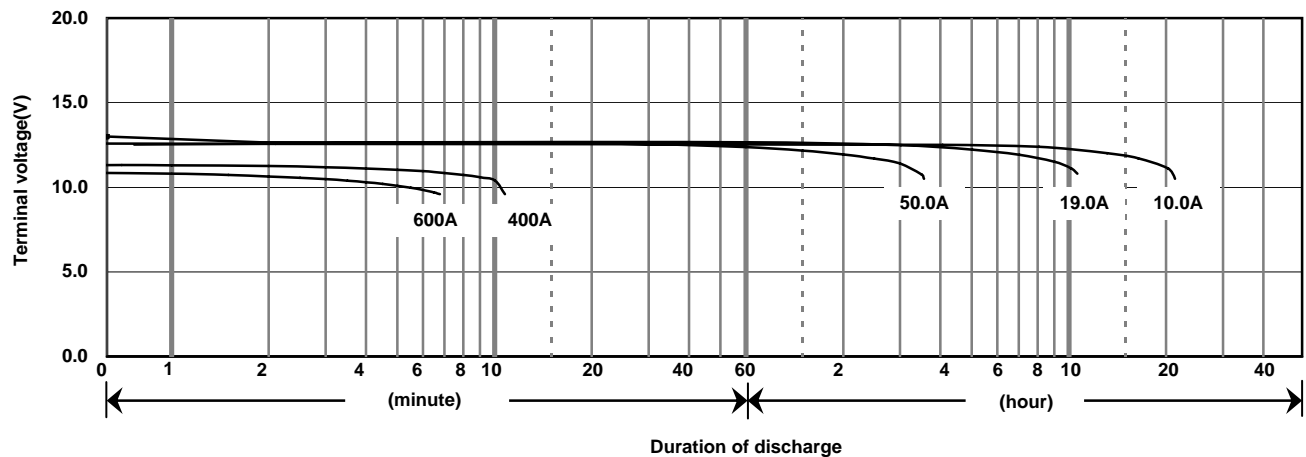

**Caution**

Due to the potential energy stored in the batteries, Please read 《Precautions for handling the Rechargeable Valve Regulated Lead Acid Batteries》 before using batteries. If improper handling or use of the batteries without understanding 《Precautions for handling the Rechargeable Valve Regulated Lead Acid Batteries》 may result in bodily injury caused by electrolyte leakage, heat generation, or explosion.

**Panasonic Storage Battery (Shenyang) Co., Ltd**

NO. 51 Kunminghu Street, Shenyang Economic & Technical Development Zone, 110141 China  
Tel: 86 24 25818921  
Fax: 86 24 62786318  
Website: <http://www.panasonicbattery.cn>

2010.11